









BEAUBIEN SUSPENSION

The Beaubien Collection's strong black lines bend in and out of space, moving effortlessly between simplicity and ornamentation. Round and cubic brass connectors complete the lamps' structures and add a rich material contrast to the powder coated rods. The collection's industrial and graphic aesthetic is imbued with a palette of influences, from traditional Chinese screens to the Memphis movement. Each influence strengthens the collection, creating nuance within its timeless character.

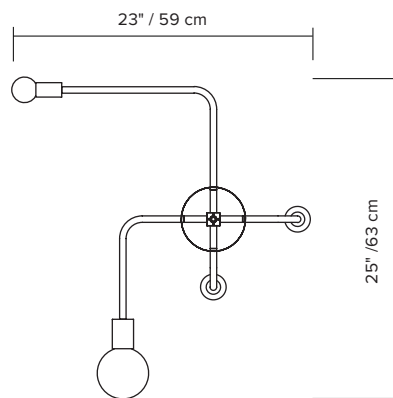
- type:** pendant
- construction:** powder coated aluminium body
powder coated steel canopy
brass hardware
milk glass globes
- specifications:** source: LED lamp provided (G9 base)
power consumption: 1 x 4.5W + 3 x 3.5W
lumen output: 1272lm
colour temperature: 2700K included
* 3000K available upon request
colour rendering index: 80 CRI standard
* ≥ 90 CRI upon request
expected lifetime: 25 000h
- control:** refer to our recommended list of dimmer models
- total height:**
- | | | | | | |
|-------|-------|-------|-------|--------|--------|
| 23" | 27" | 31" | 35" | 41" | 53" |
| 58 cm | 69 cm | 79 cm | 90 cm | 104 cm | 135 cm |
- weight:** min. 2.4lb / 1.1kg
- certifications:**     IP20
- warranty:** 2 years



-  G80 $\varnothing \pm 3" / 80 \text{ mm}$
-  G50 $\varnothing \pm 2" / 50 \text{ mm}$

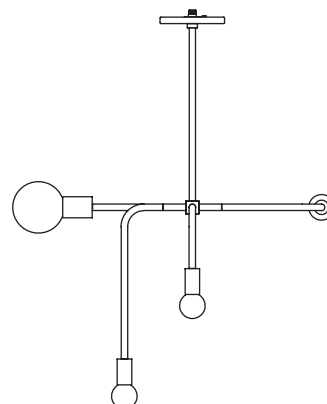
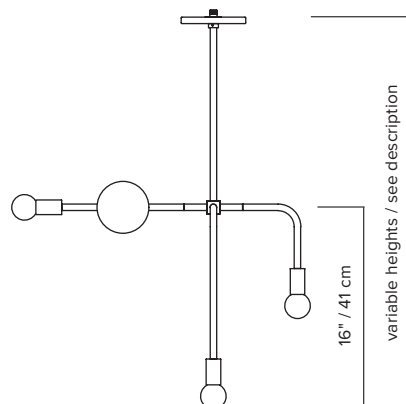

*dimensions are approximate and may vary slightly

ORDER GUIDE: SKU

COLLECTION		MODEL	FINISH	HARDWARE	HEIGHT
BEA	Beaubien	02	BK black	BR brass	A 23" / 58 cm
				GR graphite	B 27" / 69 cm
					C 31" / 79 cm
					D 35" / 89 cm
					E 41" / 104 cm
					F 53" / 135 cm
					V custom
BEA		02	BK	BR	A = BEA02BKBRA example

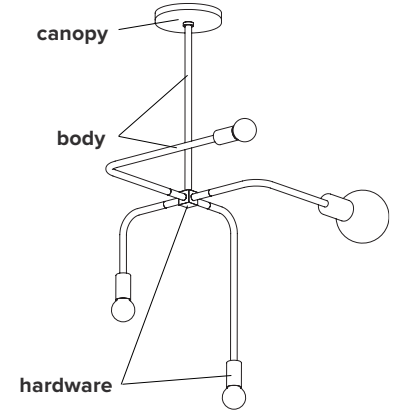

FINISH



flat
black

HARDWARE



graphite



brass

CANOPY swivel option for slanted ceiling

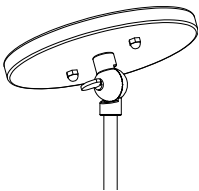

NOTES:

- must be installed by an electrician
- not protected against liquids (refer to IP20)
- additional charges for modifications or for special orders
- please refer to maintenance sheet on website for cleaning instructions

DIMMER SPECIFICATIONS

DIMMER LIST COMPATIBILITY FOR G9 LED BULBS – 120V

The dimming technology offering the best results is ELV (electronic low voltage) dimmers with reverse phase or trailing edge control.

DIMMER BRAND	MODEL NUMBER	MIN LEVEL	MAX LEVEL	FLICKERING	OVERALL QUOTE
LUTRON - MAESTRO	MAELV-600	0%	100%	0%-10%	good
LUTRON - SKYLARK	SELV-300P	0%	100%	no	very good
LUTRON - SKYLARK	SELV-303P	0%	100%	no	very good
LUTRON - SKYLARK	CTELV-303P	0%	100%	no	very good
LUTRON - DIVA	DVELV-300P	0%	100%	no	very good
LEGRAND - ADORNE	TRUE UNIVERSAL	30%	100%	no	good

DIMMER LIST COMPATIBILITY FOR G9 LED BULBS – 230V

DIMMER BRAND	MODEL NUMBER	MIN LEVEL	MAX LEVEL	FLICKERING	OVERALL QUOTE
VARILIGHT	V-PRO	2%	100%	no	very good
LEGRAND - NILOÉ	3 996 35	15%	87%	no	good
NIKO	310-0280X	5%	94%	no	very good
NIKO	310-0190X	1%	100%	no	very good

*Other dimmers can yield good results and we recommend conducting your own test before final installation.

EU ENERGY LABEL

