



## CLIFF SUSPENSION



<b>type</b>	suspension				
<b>materials</b>	body :	brass (BR)			
	sphere :	milk glass (G50 / G80)			
	hardware :	brass			
<b>total height</b>	24"	30"	36"	42"	54"
	610 mm	762 mm	914 mm	1067 mm	1372 mm
<b>weight (min.)</b>	min. 3.7 lb / 1.7 kg - max. 4.1 lb / 1.9 kg				
<b>light bulb</b>	LED (included), 1x 4.5W + 4 x 3.5W				
<b>sockets</b>	G9				
<b>voltage</b>	120V / 240V				
<b>dimmer</b>	refer to our recommended list of dimmer models				
<b>certifications</b>	 				
<b>notes</b>	<ul style="list-style-type: none"> <li>- must be installed by an electrician;</li> <li>- additional charges for modifications or for special orders;</li> <li>- lead time between 7-9 weeks;</li> <li>- dimensions are approximate and may vary slightly.</li> </ul>				

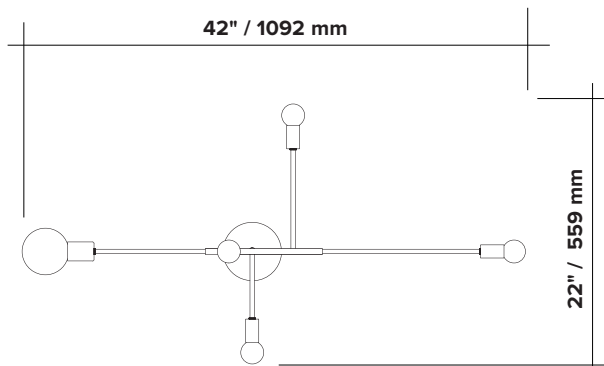
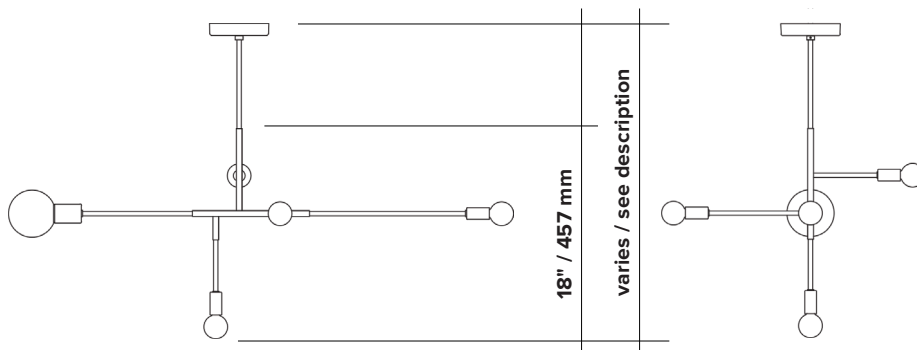

## ORDER GUIDE: SKU

COLLECTION	MODEL	FINISH	HEIGHT
CLI cliff	01	BR brass	A 24" / 610 mm
		GR graphite	B 30" / 762 mm
			C 36" / 914 mm
			D 42" / 1067 mm
			E 54" / 1372 mm
			V custom
CLI	01	BR	A = CLI01BRA

example

### FINISH

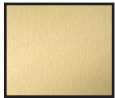

brass



graphite

### CANOPY swivel option for slanted ceiling

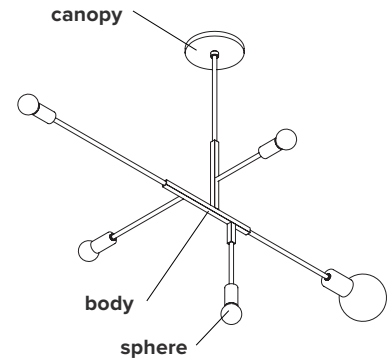
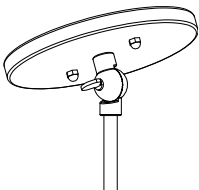

## LIGHT BULB & DIMMER SPECIFICATIONS

### G9 SOCKETS

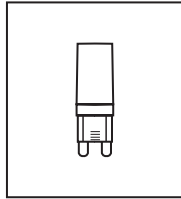

Frosted  
4.5W  
100V-120V / 240V  
450 Lumens  
2700 K  
25 000 H  
CRI ≥80  
2 years warranty

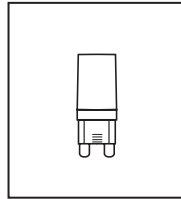

Frosted  
3.5W  
100V-120V / 240V  
350 Lumens  
2700 K  
25 000 H  
CRI ≥80  
2 years warranty



### SPHERES



G80  $\varnothing$  ±3" / 80 mm



G50  $\varnothing$  ±2" / 50 mm

### DIMMER LIST COMPATIBILITY FOR G9 LED BULBS – 120V

The dimming technology offering the best results is ELV (electronic low voltage) dimmers with reverse phase or trailing edge control.

<u>DIMMER BRAND</u>	<u>MODEL NUMBER</u>	<u>MAX LEVEL</u>	<u>MIN LEVEL</u>	<u>FLICKERING</u>	<u>OVERALL QUOTE</u>
LUTRON - MAESTRO	MAELV-600	100%	0%	0%-10%	good
LUTRON - SKYLARK	SELV-300P	100%	0%	no	very good
LUTRON - SKYLARK	SELV-303P	100%	0%	no	very good
LUTRON - SKYLARK	CTELV-303P	100%	0%	no	very good
LUTRON - DIVA	DVELV-300P	100%	0%	no	very good
LEGRAND - ADORNE	TRUE UNIVERSAL	100%	30%	no	good

### DIMMER LIST COMPATIBILITY FOR G9 LED BULBS – 230V

<u>DIMMER BRAND</u>	<u>MODEL NUMBER</u>	<u>MAX LEVEL</u>	<u>MIN LEVEL</u>	<u>FLICKERING</u>	<u>OVERALL QUOTE</u>
VARILIGHT	V-PRO	100%	2%	no	very good
LEGRAND - NILOÉ	3 996 35	87%	15%	no	good
NIKO	310-0280X	94%	5%	no	very good
NIKO	310-0190X	100%	1%	no	very good

\*Other dimmers can yield good results and we recommend conducting your own test before final installation.